

● KDC-416S

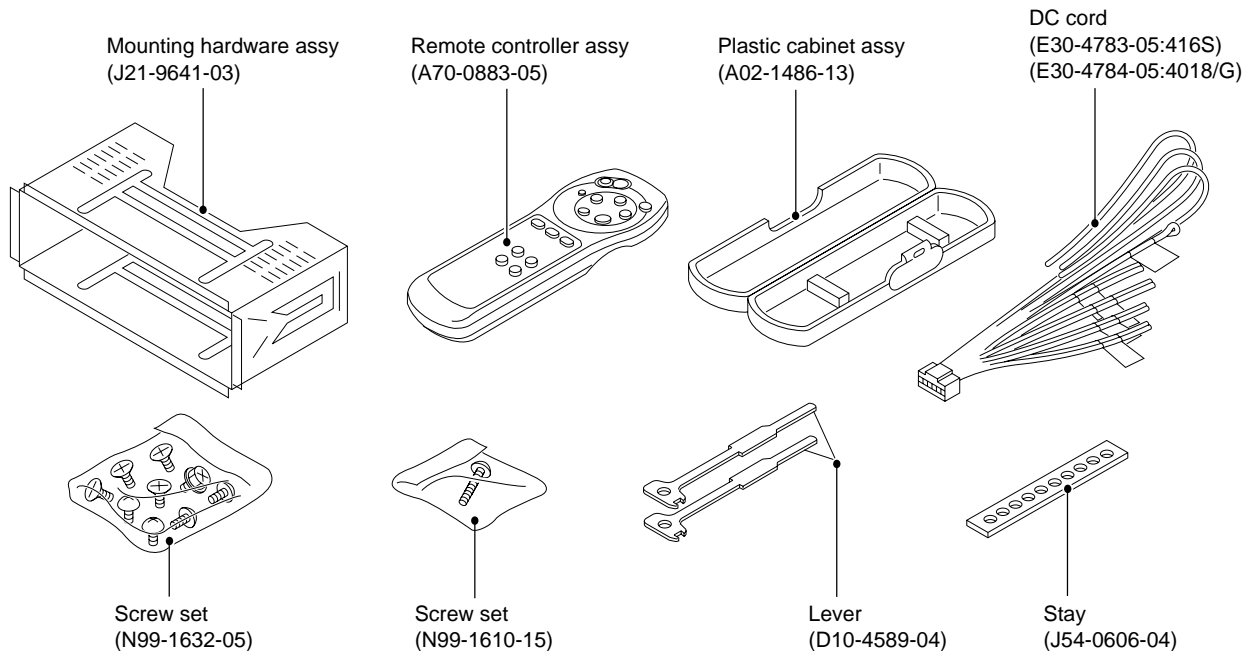

KDC-416S/4018/G

BLOCK DIAGRAM

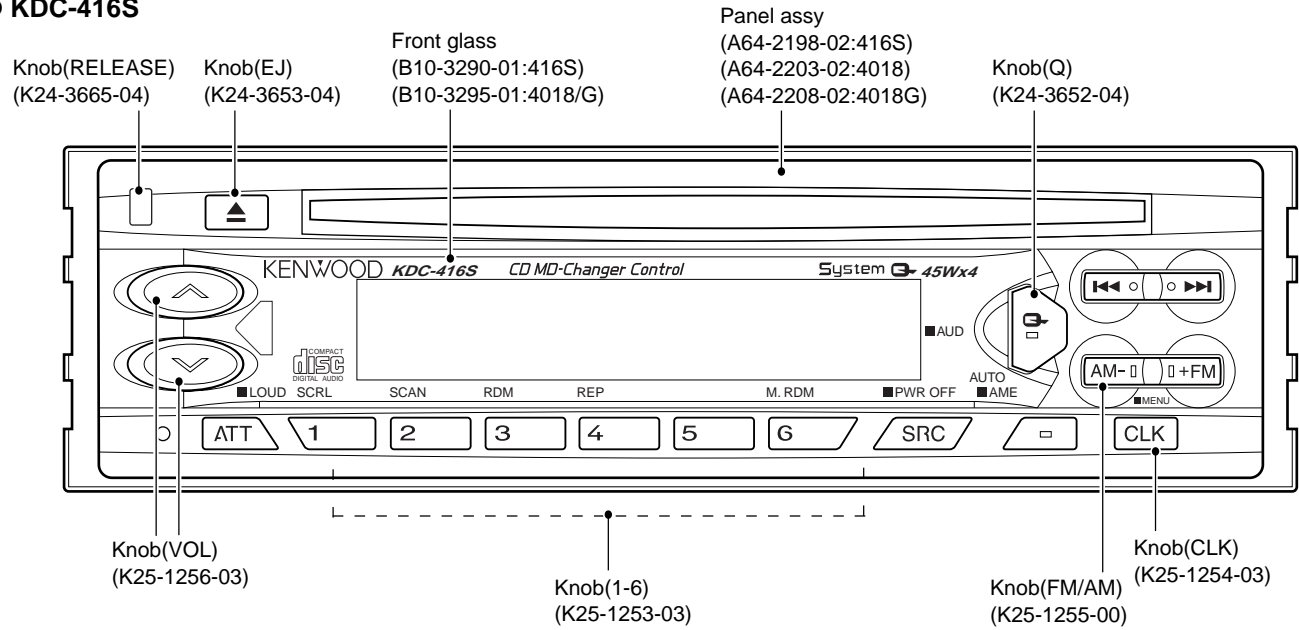
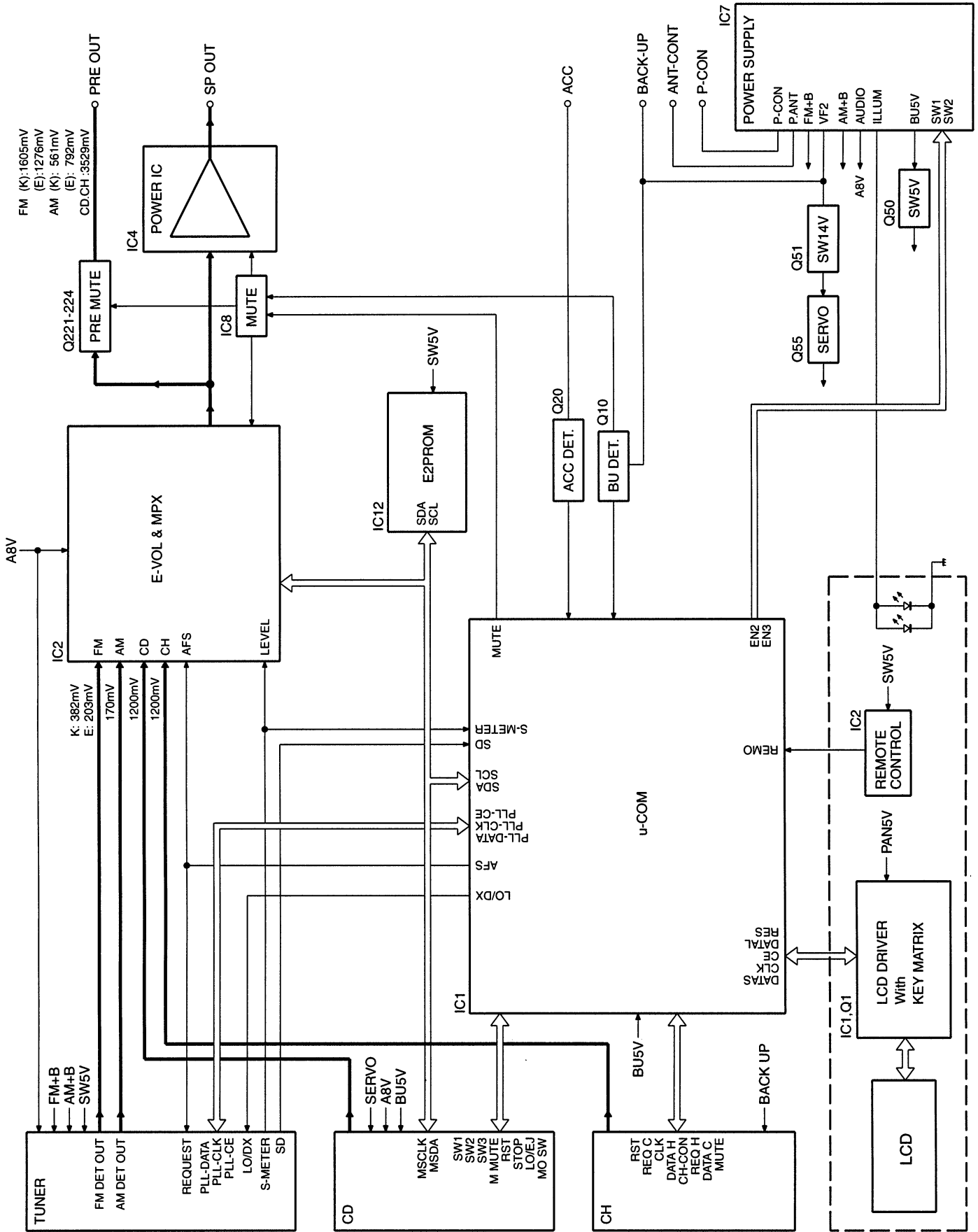

KDC-416S/4018/G

COMPONENT DESCRIPTION

●SWITCH UNIT(X13-9870-10)

Ref.No.	Component Name	Application/Function	Operation/Condition/Compatibility
IC1	LC75883E	LCD driver	Ready on key-matrix
IC2	RS-171	Remote control light sensor	
Q1	DTA114EK or KRA102S or UN2111	key-matrix permission SW	Ready on key-matrix, ON when the base goes "Lo"

●ELECTRIC UNIT(X25-8690-XX)

Ref.No.	Component Name	Application/Function	Operation/Condition/Compatibility
IC1	UPD780058GC230	System μ -COM.	
IC2	TDA7407D	E-VOL. & N.C. MPX	
IC4	TDA7386	Power IC	
IC7	BA4911-V4	Power supply IC	
IC8	HD74HC27FP	Mute gate IC	3 input NOR gate x3
IC11	S-80830ANNP	RESET IC	Detection voltage 3.0V
IC12	BR24C01AF or BR24C01AF-W M24C01-WMN6T or S-24C01B	E2PROM	
Q10	2SC4081 or 2SD1819A	B.U. detection	Detect BU voltage
Q20	2SC4081 or 2SD1819A	ACC detection	Detect ACC voltage
Q40	DTA124EUA or UN5112	PREOUT mute driver	Mutes when base is "Lo" (controls Q221-224)
Q50	2SA1036K	SW 5V	ON when the base is "Lo".
Q51	UMC2N	SW 14V	ON when the base is "Hi" (controls Q55)
Q53	UMC2N	Switch for power supply IC	ON when the base is "Hi" (controls SW1 pin of power supply IC)
Q55	2SD2375 or 2SD2396	AVR for SERBO +B	Output issued when SW14V is on (base is "Hi")
Q70	2SC4081 or 2SD1819A	SURGE detection	Detect SURGE voltage
Q101	2SC4081 or 2SD1819A	DSI SW	DSI LED turns ON when base is "Hi"
Q102	DTA114YUA or UN5114	PANEL 5V SW	ON when the base is "Lo"
Q221-224	DTC143TUA or UN5216	PREOUT MUTE	Mute applied to PREOUT (output) when base is "Lo"
Q251	DTC114YUA or UN5214	Power IC SVR SW	Turns ON when base is "Hi" and capacitor on SVR pin discharges

KDC-416S/4018/G

MICROCOMPUTER'S TERMINAL DESCRIPTION

●Terminal Description

Pin	Function	I/O	Description	Processing Operation
1	AV CONT	O	A/D converter reference voltage control output	"Hi": ON / "Lo": OFF
2	IC2 TYPE0	I	IC2 setting terminal	"Lo": Initial value
3	IC2 TYPE1	I	IC2 setting terminal	"Lo": Initial value
4	AVSS	-	Ground connection terminal	connected to GND
5	M MUTEL	I	Muting request from the MICOM. of CD mecha.	"Lo": Mute request
6	N.C	O	Not used	
7	AVREF1	I	D/A converter reference voltage input	
8	ILLUMI	O	Illumination AVR ON/OFF control output	"Hi": AVR ON
9	L RES	O	Reset output to the LCD driver IC	"Lo": Reset
10	PANEL	I	Panel open/close detection input	"Lo": Panel closed
11	L DATAL	I	Data input from the LCD driver IC	
12	L DATAS	O	Data output to the LCD driver IC	
13	L CLK	O	Clock output to the LCD driver IC	
14	N.C	O	Not used	
15	N.C	O	Not used	
16	CH-DATAC	I	Data input from changers	
17	CH-DATAH	O	Data output to changers	
18	CH-CLK	I/O	Clock input/output with changers	
19	L CE	O	CE output to the LCD driver IC	"Hi": Active
20	N.C	O	Not used	
21	M RST	O	Reset output to the MICOM. of CD mecha.	"Lo": Reset
22	M STOP	O	Stop request to the MICOM. of CD mecha.	"Lo": Stop
23	MOSW	O	CD mechanism loading motor control output	"Hi": Loading & Eject / "Lo": other
24	PLL SCL	O	Clock output to the tuner pack	
25	AM+B	O	AM+B control	"Hi": during AM reception
26	FM+B	O	FM+B control	"Hi": during FM reception
27	M-SCL	I/O	Clock input/output with the MICOM. of CD mecha.	
28	DSI	O	DSI output	"Hi": LED ON
29	LO/EJ	I/O	CD mecha.Loading/Eject switching output	"Lo": Loading / "Hi": Eject
30	SW3	I	Down & limit switch detection input	"Hi": Chucking / "Lo": Pickup most inner position
31	R DATA	I	Data input from RDS decoder	
32	R QUAL	I	Quality input from RDS decoder	
33	VSS1	-	Ground connection terminal	connected to GND
34	SD	I	SD input from the tuner pack	"Hi": Station detected
35	IC2 SCL	O	Clock output to the E-VOL. IC	
36	M-SDA	I/O	Data input/output with the MICOM. of CD mecha.	
37	PLL SDA	I/O	Data input/output with the tuner pack	
38	IC2 SDA	I/O	Data input/output with the E-VOL. IC	
39	MUTE	O	Mute control output	"Hi": Mute ON / "Lo": Mute OFF
40	N.C	O	Not used	
41	AFC	O	AFC control output	"Lo": during FM seek
42	CH-REQH	O	Request output to changers	"Lo": Request
43	CH-CON	O	Changer control	"Lo": Standby / "Hi": ON
44	N.C	O	Not used	
45	P MUTE	O	Power IC mute control	"Lo": Mute
46	SVR	O	Power IC reset terminal	When the momentary power down, after ACC OFF/ON is detected and after POWER ON/OFF, the output goes "Hi" temporarily.
47	STBY	O	Power IC standby control output	"Hi": POWER ON mode
48	P CON	O	Power control	"Hi": POWER ON mode except ALL OFF mode
49	P ANT	O	Antenna control	"Hi": during FM/AM reception
50	BEEP	O	BEEP sound output	
51	ACC DET	I	ACC detection input	"Hi": ACC OFF / "Lo": ACC ON
52	BU DET	I	Momentary power down detection input	"Hi": When momentary power down detected or BU OFF / "Lo": BU ON
53	N.C	O	Not used	

KDC-416S/4018/G

MICROCOMPUTER'S TERMINAL DESCRIPTION

Pin	Function	I/O	Description	Processing Operation
54	N.C	O	Not used	
55	N.C	O	Not used	
56	SW5	O	SW 5V control	"Lo": POWER ON mode
57	P ON	O	Microprocessor peripheral power supply control terminal	"Hi": ACC ON or during CD Loading/Eject
58	TYPE2	I	Destination type input terminal 2	
59	N.C	O	Not used	
60	RESET	I	Reset input terminal	"Lo": System reset
61	REMO	I	Data input from the remote control light sensor	
62	R CLK	I	Clock input from RDS decoder	
63	CH-REQC	I	Request input from changers	"Hi": Request
64	SW1	I	Loading detection	"Lo": CD chucking
65	KEY-REQ	I	Key request terminal	"Lo": Request
66	SW2	I	12cm disc detection terminal	"Lo": 12cm disc
67	VSS0	-	Ground connection terminal	connected to GND
68	VDD1	-	VDD connection terminal	
69	X2	-	Main clock resonator connection terminal	
70	X1	I	Main clock resonator connection terminal	
71	IC(TEST)	-	Not used	connected to GND
72	XT2	-	Sub clock resonator connection terminal	N.C.
73	N.C	I	Sub clock resonator connection terminal	connected to BU5V lines
74	VDD0	-	VDD connection terminal	
75	AVREF0	I	A/D converter reference voltage input	
76	SMETER	I	S-meter input from the tuner pack	
77	PHONE	I	PHONE detection input	1V or less: TEL MUTE, 2.5V or greater: NAVI MUTE
78	NOISE	I	Noise detection input	
79	TYPE0	I	Destination type input terminal 0	
80	TYPE1	I	Destination type input terminal 1	

KDC-416S/4018/G

ADJUSTMENT

Test Mode

1. How to enter test mode

While holding the FM key and preset 6 key, reset the unit. All display segments light up when the test mode is entered.

2. How to exit from test mode

Reset the unit. The test mode is not terminated by turning ACC off, power off, momentary power down or panel detaching.

3. Test mode specifications of CD receiver

- Pressing the Track Up key jumps to tracks in the following sequence:
No.9→No.15→No.10→No.11→No.12→No.13→No.14→No.9 (Repeats the cycle)
- Pressing the Track Down key jumps to the track immediately before the track being played.
- Pressing Preset 1 key jumps to track No. 28.
- Forced ejection is not provided.

4. Test mode specifications of cassette receiver

- Blank skip (B.S) is off.
- Pressing the ATT key ejects the cassette.

5. Audio functions

- Pressing the AUDIO key or the OPEN/CLOSE key on the remote controller initiates the Audio mode.
- In the Audio adjustment mode, the Seek Up/Down keys on the remote controller can only be pressed shortly. (They cannot be held depressed.)
- The volume is -10 dB (which is displayed as "30").
- LOUDNESS is OFF.
- The Bass/Treble Up/Down and Balance/Fader Up/Down buttons function as full-boost/full-cut and full-front/full-rear respectively.

6. Menu mode

- Pressing the CLK or the DNPP key on the remote controller initiates the Menu mode.
- In the Menu mode, the Seek Up/Down keys on the remote controller can only be pressed shortly. (They cannot be held depressed.)
- With the models incorporating RDS, the first operation in the menu becomes local seek.

7. Version and operating hours display

- The following table shows the key operations and resulting display information.

Key Operation	Display
Pressing Preset 1	Version (Date and time display)
Pressing Preset 3	CD (or TAPE with C/R models) operating hours
Pressing Preset 5	CD (or TAPE with C/R models) ejection count

- Holding Preset 3 while the operating hour information is displayed clears it.
- Holding Preset 5 while the ejection count information is displayed clears it.

Adjustment Mode

Adjustable items

- Stereo Decoder Subaddress: 9
- Configuration Subaddress: D

Default values

If they are not written in the EEPROM, the default values specified by the IC developer are set in IC2-3.

Adjustment procedure

- Enter the IC2-3 Adjustment mode by resetting the unit while holding [3] + [6].
- Select the TUNER source by pressing SRC.
- When the adjustment mode is entered, the display shows a 2-digit hex number.
- When preset [1] or [2] is recalled, the setting values corresponding to the pressed number are displayed. (The displayed values are those in the RAM.)
- Vary each setting value using [◀] or [▶].
- Store the values in the corresponding preset number.
- The settings can be performed individually for each item. (It is not required to store all the values together.)
- After storing the values, reset the unit to exit from the adjustment mode. The values set in the EEPROM will be read during the resetting.
- When the band is switched, there may be cases in which the preset number being displayed does not coincide with the stored setting value. To check this, be sure to recall the preset number after you switch the band.

Notes

- The items which are not stored will be set to the default values.
- Once a value is stored in memory, the value will always be used later. (It is not allowed to modify the setting values by switching the destination type.)

PC BOARD (Component Side View)

ELECTRIC UNIT

X25-8690-XX(J74-1122-12)

ELECTRIC UNIT
(X25-8690-XX)

Ref. NO.	IC	Q	Address
1			5F
2			4C
4			2D
6			5B
7			3F
8			4E
11			5F
12			4D
10			3E
20			3E
40			3C
50			4E
51			3G
53			4E
55			2G
70			3E
101			6F
102			6F
201			4C
221			3C
222			3C
223			2B
224			2B
251			3D
301			4B

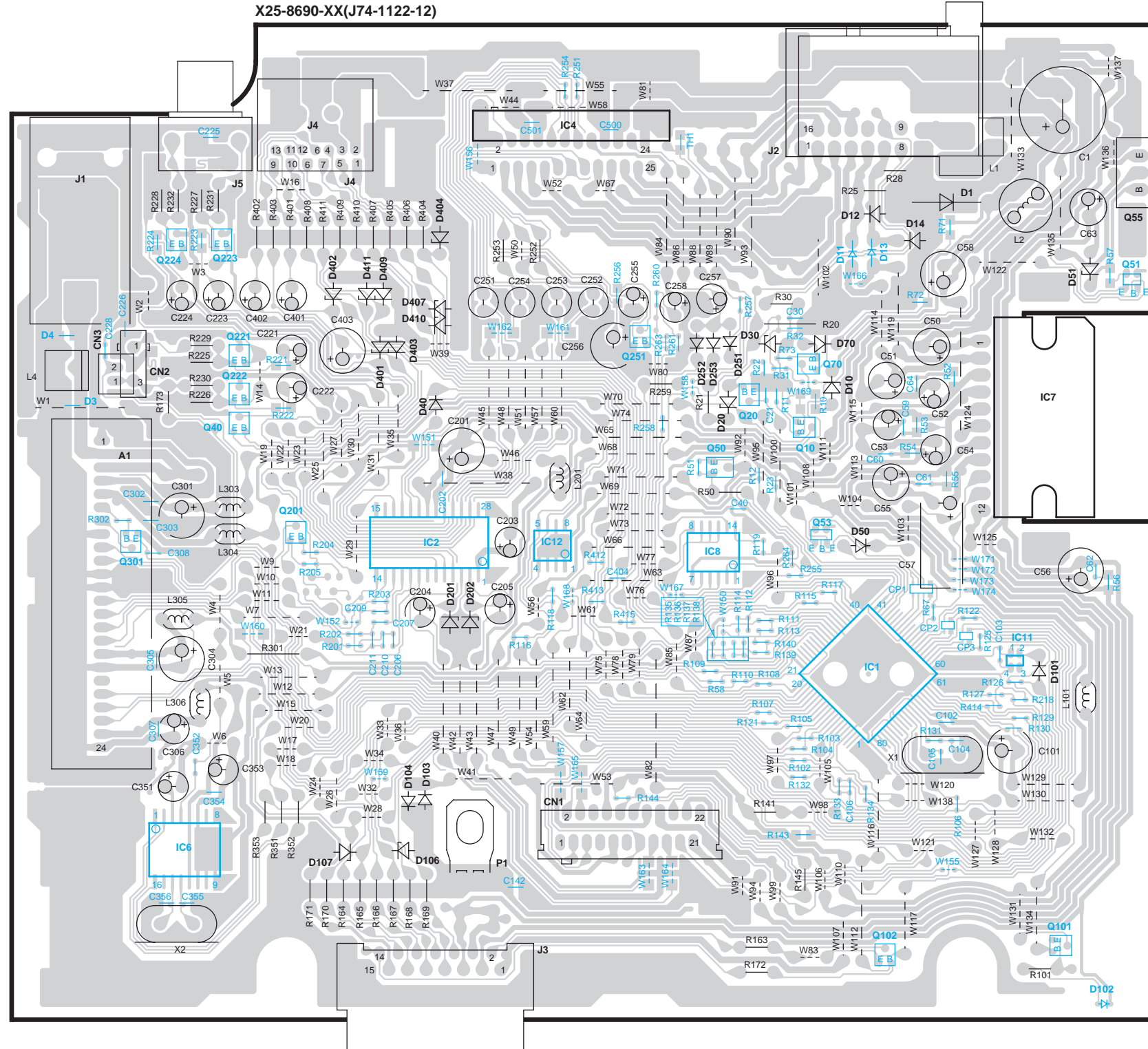

SWITCH UNIT

X13-9870-10(J74-1112-12)

SWITCH UNIT
(X13-9870-10)

Ref. NO.	IC	Q	Address
1			4H
2			6H
301			2H

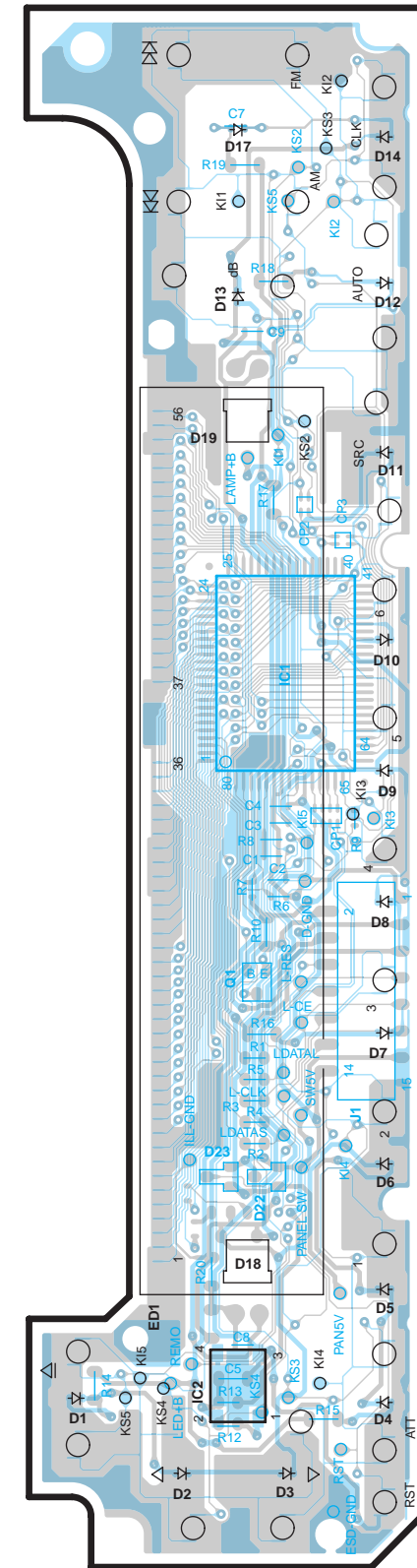

Refer to the schematic diagram for the values of resistors and capacitors.

PC BOARD (Foil Side View)

SWITCH UNIT

X13-9870-10(J74-1112-12)

SWITCH UNIT
(X13-9870-10)

Ref. NO.	IC	Q	Address
1			4K
2			6K
301			2K

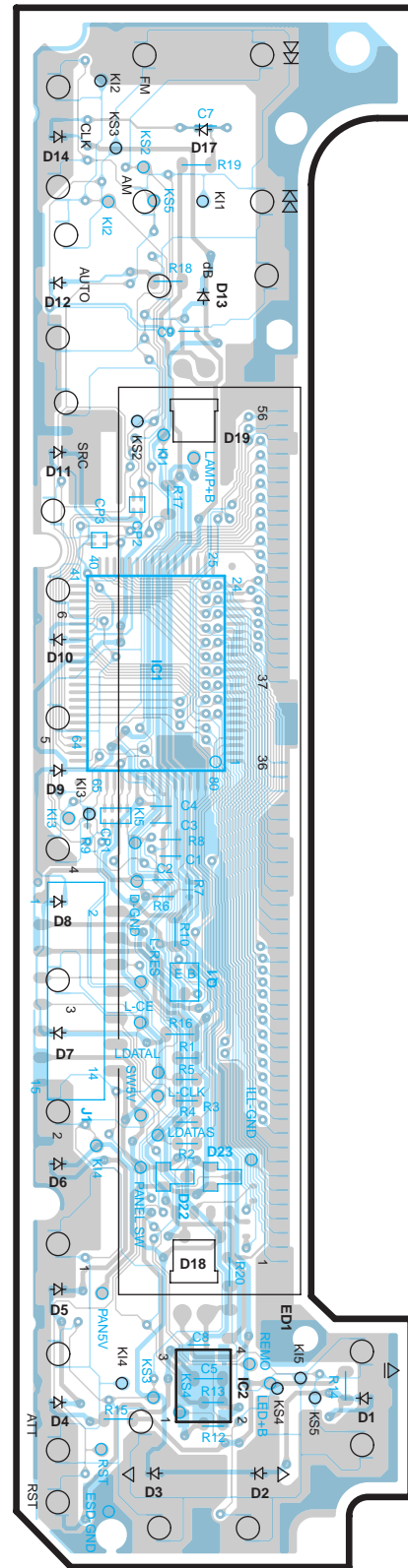

ELECTRIC UNIT

X25-8690-XX(J74-1122-12)

ELECTRIC UNIT
(X25-8690-XX)

Ref. NO.	IC	Q	Address
1			5M
2			4P
4			2O
6			5Q
7			3M
8			4N
11			5M
12			4O
10			3N
20			3N
40			3P
50			4N
51			3L
53			4N
55			2L
70			3N
101			6M
102			6M
201			4P
221			3P
222			3P
223			2Q
224			2Q
251			3O
301			4Q

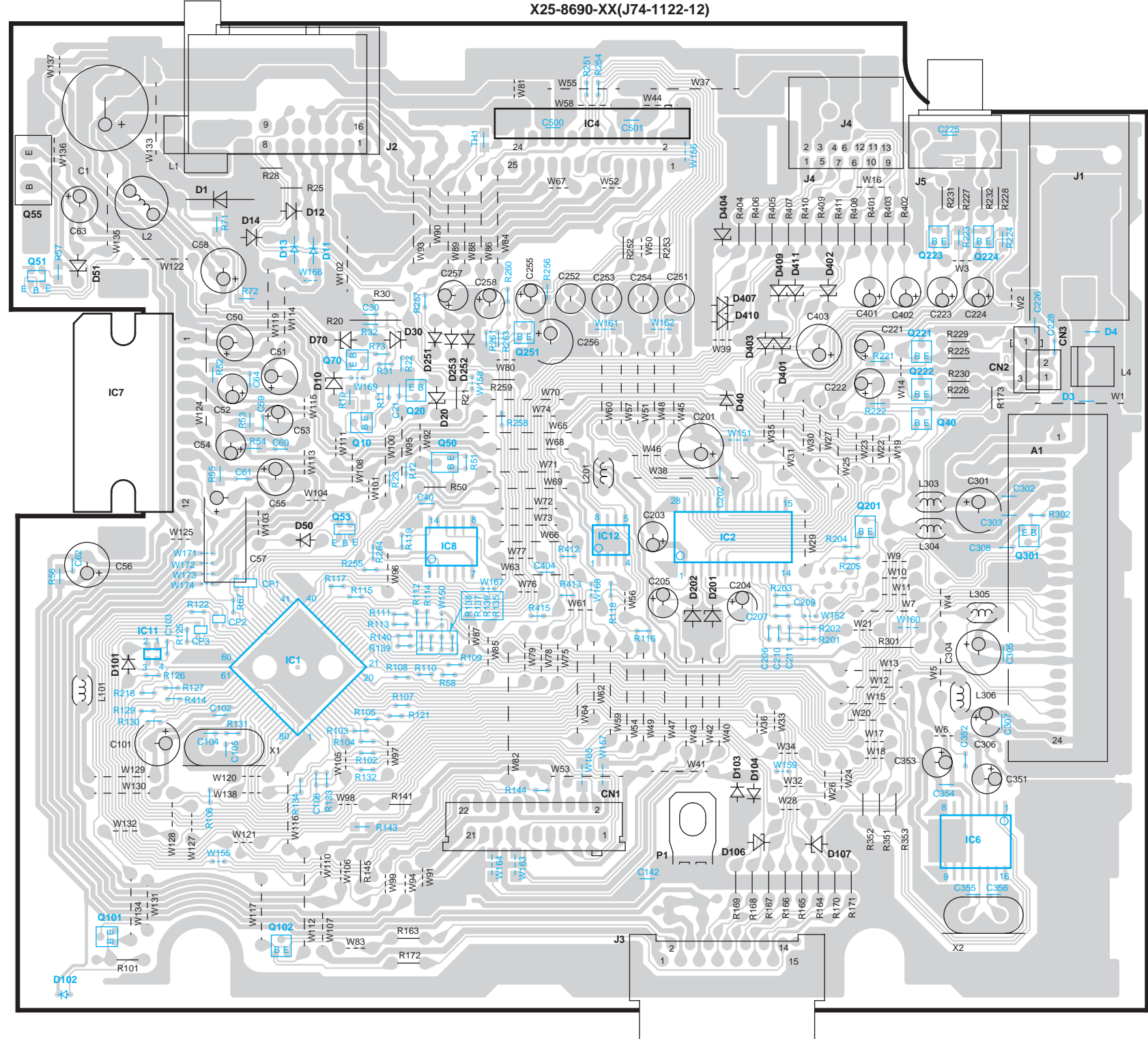

Refer to the schematic diagram for the values of resistors and capacitors.

PC BOARD (Component Side View)

PC BOARD (Foil Side View)

CD PLAYER UNIT

CD PLAYER UNIT

CD PLAYER UNIT
(X32-5010-00)

Ref. NO.	IC	Q	Address
1			4T
2			4U
4			2V
6			3V
	1		4T
	2		4V
	3		3V
	4		4U
	5		4V

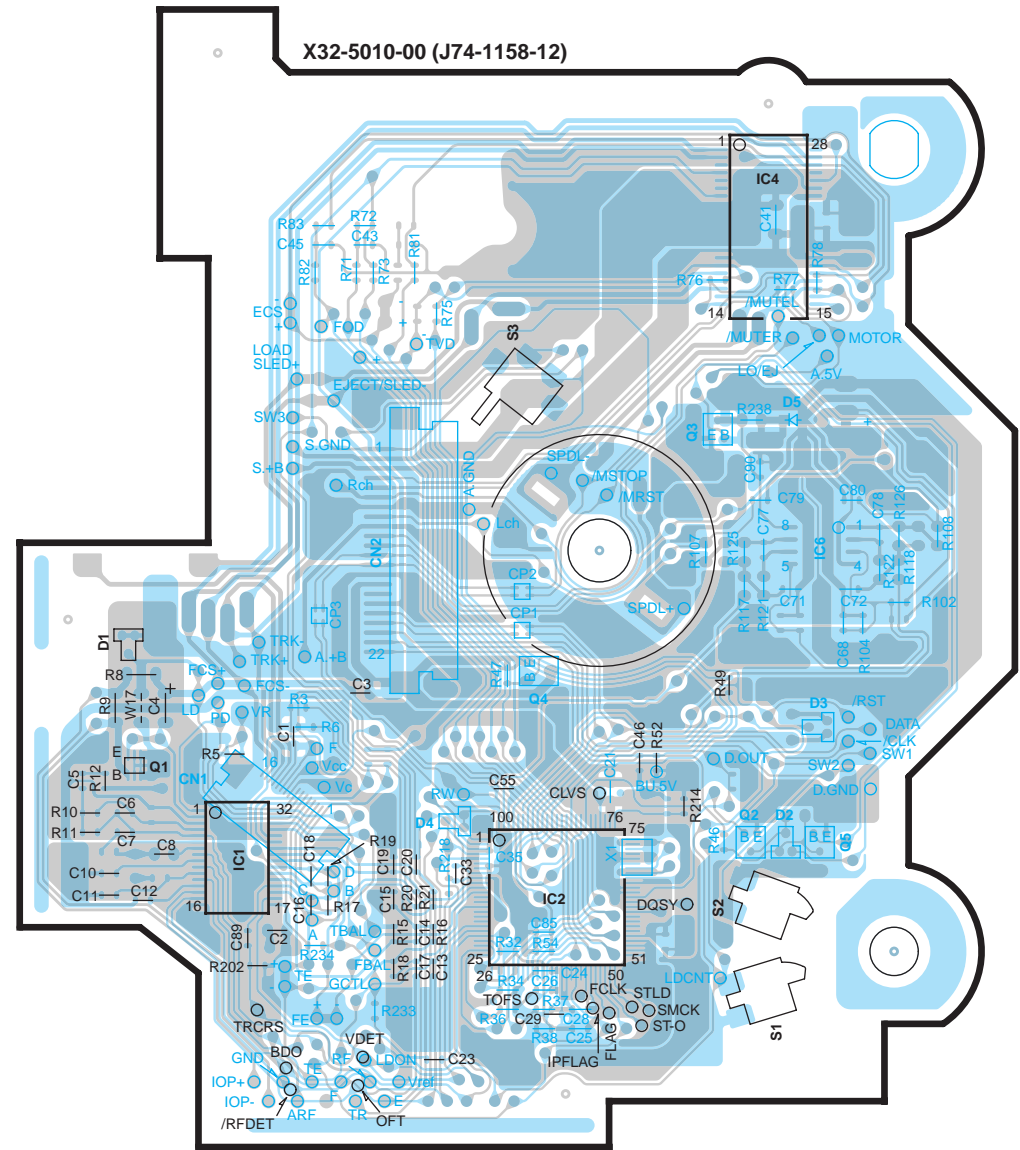

CD PLAYER UNIT
(X32-5010-00)

Ref. NO.	IC	Q	Address
1			4Z
2			4Y
4			2X
6			3X
	1		4Z
	2		4X
	3		3X
	4		4Y
	5		4X

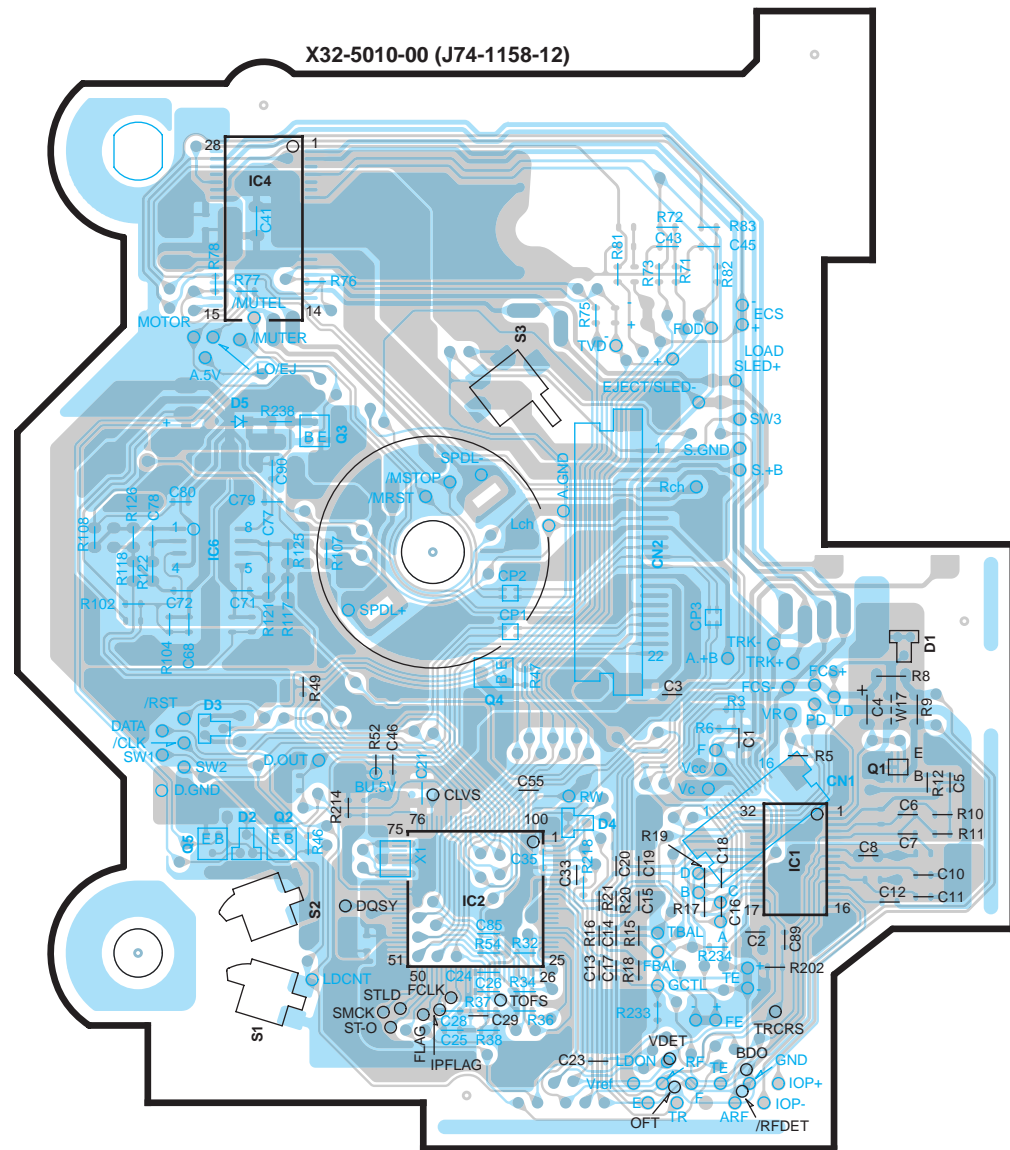

Refer to the schematic diagram for the values of resistors and capacitors.

IC1 : UPD780058GC230
 IC2 : TDA7407D
 IC4 : TDA7386
 IC7 : BA4911-1/4
 IC8 : HD74HC27FP
 IC11 : S-80830ANP
 IC12 : BR24CO1AF

D1 : S2V20*A
 D2,3,40,50,101,103,104,251-253 : 1SS133
 D4 : SA-C2012-101TB or IMSA-6801
 D10,20,70,201,202,401,402 : MA4068(N)-M
 D11-14,261-263,265,266 : AM01Z or DSM1SD2 or ERA15-02

D51 : MA4082(N)-L or HZ59A1L
 D102 : B30-1567-05
 D106,107,403,404,409-411 : SA-C2012-101TB or IMSA-6801
 D264,267,268 : D1F60

Q10,20,70,101 : 2SC4081 or 2SD1819A
 Q40 : DTA124EUA or UN5112
 Q50 : 2SA1036K
 Q51,53 : UMC2N
 Q55 : 2SD2375 or 2SD2396





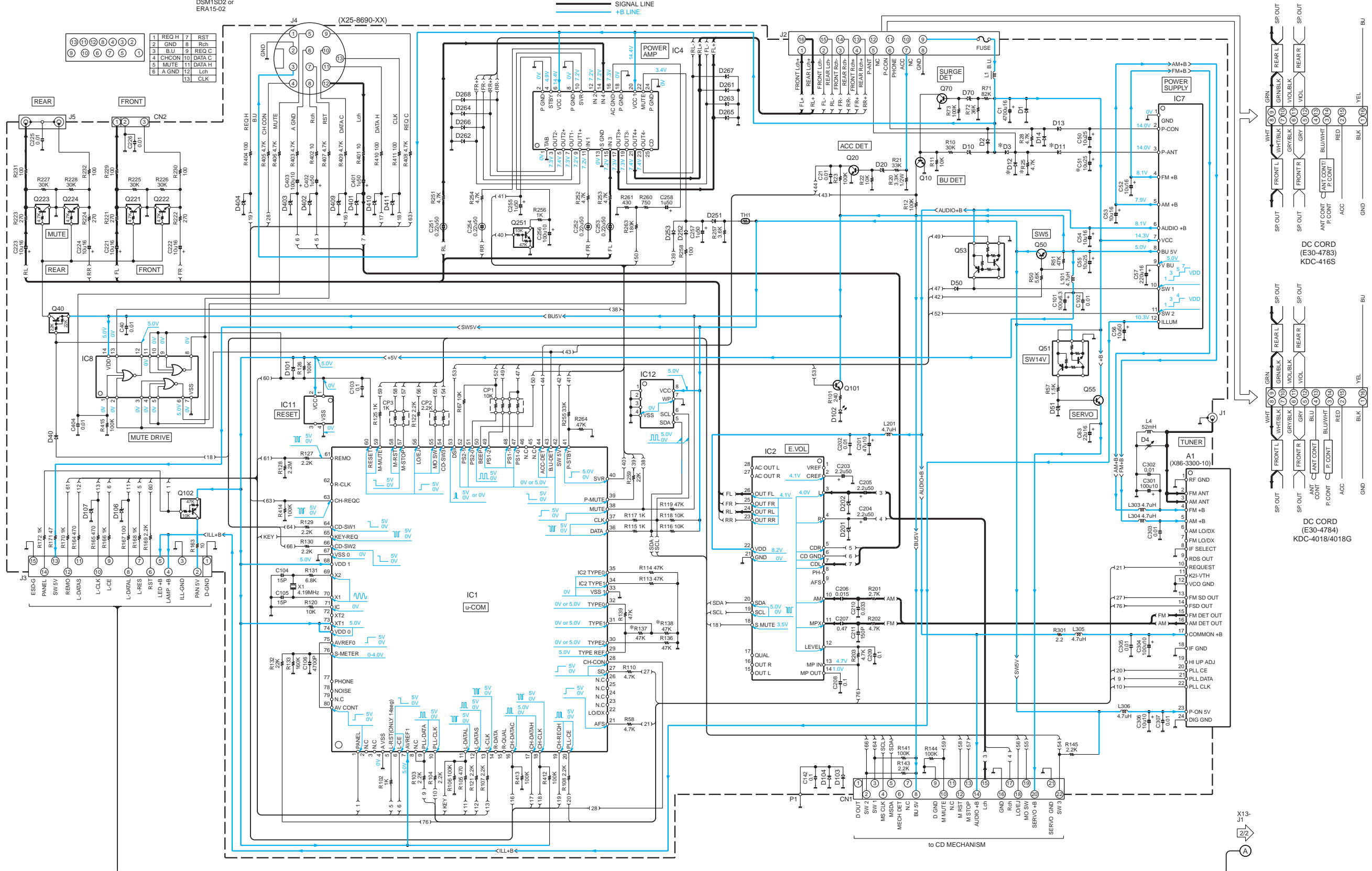

Q102 : DTA114YUA or UN5114
 Q221-224 : DTC143TUA or UN5216
 Q251 : DTC114YUA or UN5214

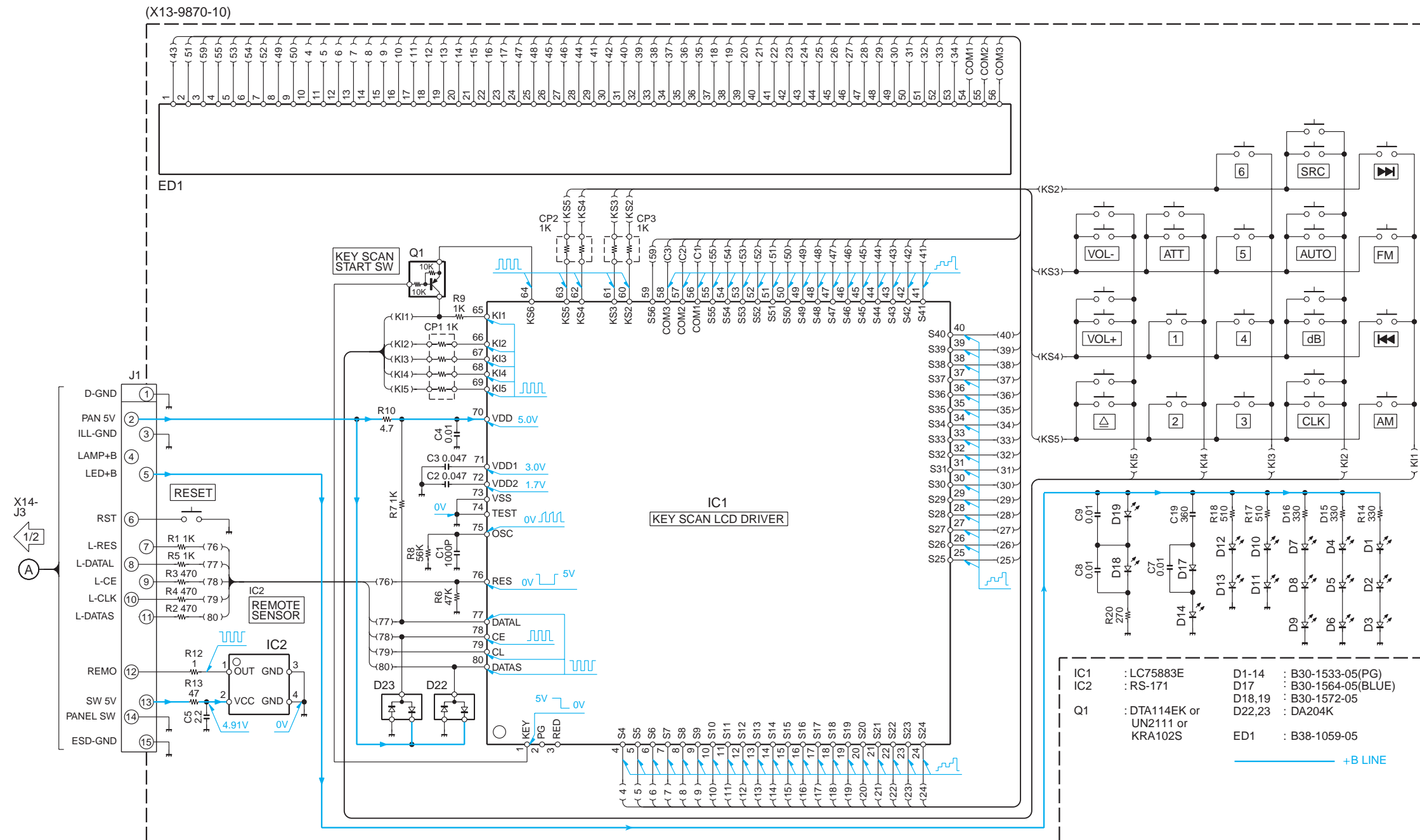
(X25-8690-XX)

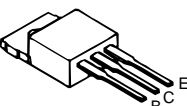
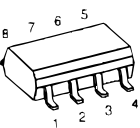
MODEL NAME	UNIT No.	C51	D3, 11,12	R25, 137	R138
KDC-416S	0-10	NO	NO	NO	YES
KDC-4018	0-10	YES	YES	YES	NO
KDC-4018G	0-21	YES	YES	YES	NO



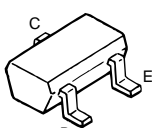

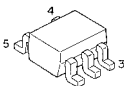
- 2SD2396 
- NJM4565MD 
- DTA114EK
- DTC114YUA
- DTC143TUA
- UN5114
- UN5214
- UN5216
- 2SA1036K
- 2SA1362
- 2SD1819A
- DAN202U 
- DA204K
- DA204U
- DTA114YUA 
- BR24C01AF
- BR24C01AF-W 
- 2SC4081 
- DTA124EUA
- DTC124EUA
- KRA102S 
- UMC2N 

IC1	: LC75883E	D1-14	: B30-1533-05(PG)
IC2	: RS-171	D17	: B30-1564-05(BLUE)
Q1	: DTA114EK or UN2111 or KRA102S	D18,19	: B30-1572-05
		D22,23	: DA204K
		ED1	: B38-1059-05

CAUTION: For continued safety, replace safety critical components only with manufacturer's recommended parts (refer to, parts list).  Indicates safety critical components. To reduce the risk of electric shock, leakage-current or resistance measurements shall be carried out (exposed parts are acceptably insulated from the supply circuit) before the appliance is returned to the customer.

DC voltages are as measured with a high impedance voltmeter. Values may vary slightly due to variations between individual instruments or/and units.

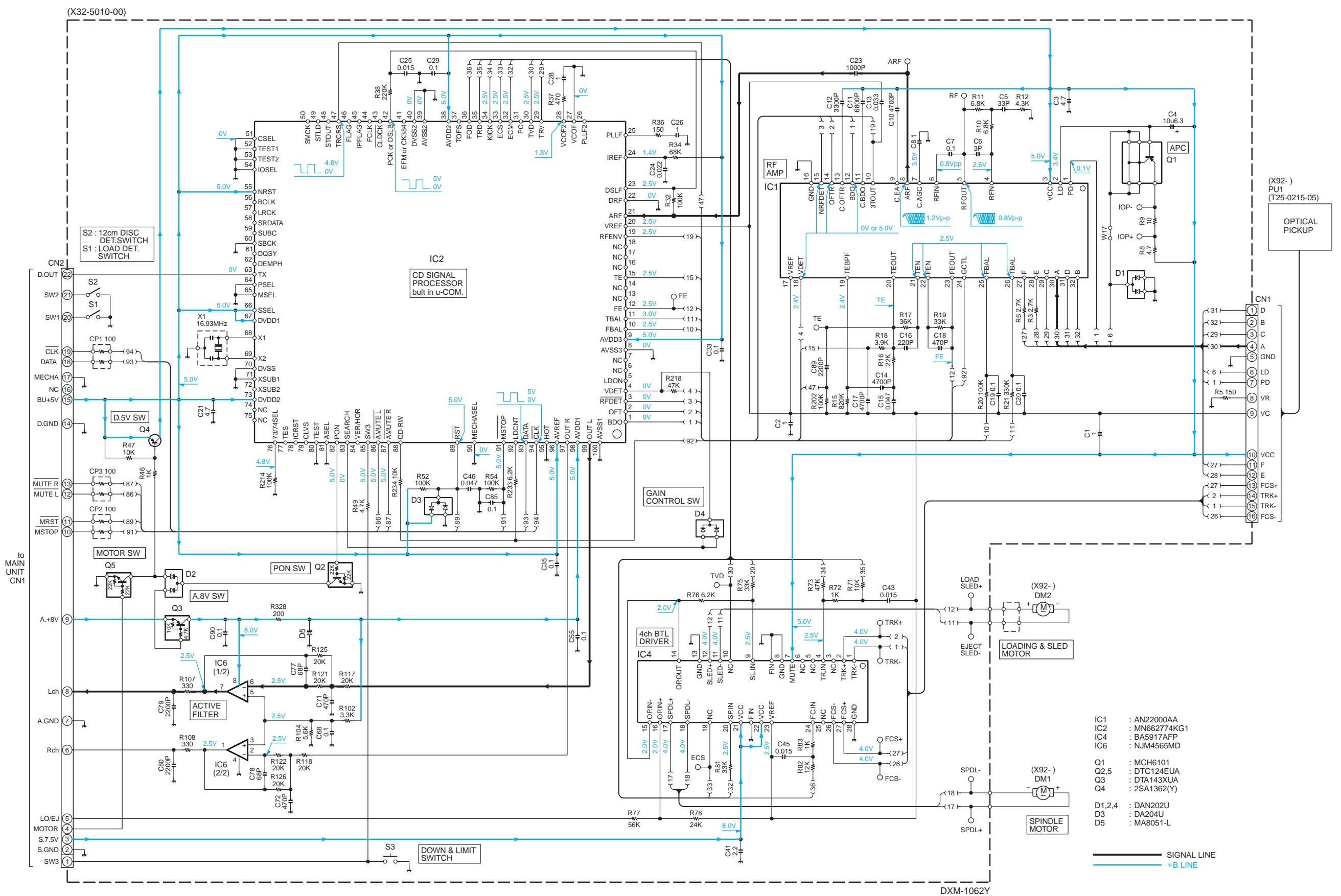

CAUTION:For continued safety, replace safety critical components only with manufacturer's recommended parts (refer to, parts list). ⚠ Indicates safety critical components. To reduce the risk of electric shock, leakage-current or resistance measurements shall be carried out (exposed parts are acceptably insulated from the supply circuit) before the appliance is returned to the customer.

DC voltages are as measured with a high impedance voltmeter. Values may vary slightly due to variations between individual instruments or/and units.

CD MECHANISM

KDC-416S/4018/G

KENWOOD

KDC-416S/4018/G

EXPLODED VIEW (CD MECHANISM)

- A M1.7x2.5 : N09-4249-05
- B $\phi 2 \times 3.5$: N09-4172-05
- C M1.7x4 : N09-4202-05
- D M2x2 : N38-2020-46
- E $\phi 2 \times 6$: N09-4294-05
- F WASHER $\phi 1.2$: N19-2023-04
- G WASHER $\phi 1.6$: N19-2058-04
- H WASHER $\phi 1.6$: N19-2093-04
- J M2x2 : N39-2020-46

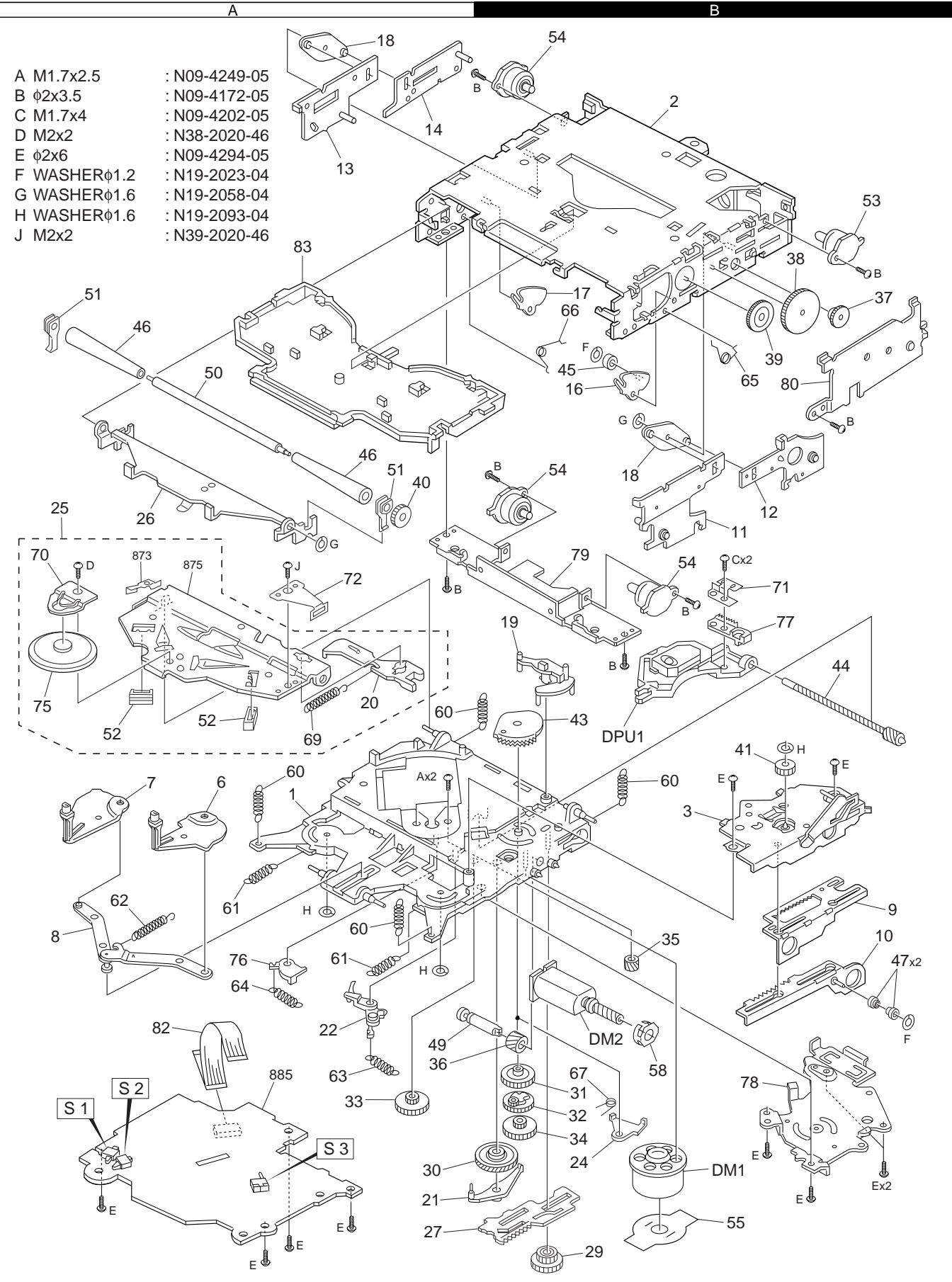

Parts with exploded numbers larger than 700 are not supplied.

KDC-416S/4018/G

EXPLODED VIEW (UNIT)

- A M3x8 : N30-3008-46
- B $\phi 2 \times 6$: N80-2006-46
- C $\phi 2 \times 8$ (BLK) : N80-2008-45
- D $\phi 3 \times 5$: N83-3005-46
- E $\phi 3 \times 10$: N80-3010-46
- F $\phi 3 \times 20$: N83-3020-46
- G $\phi 2.6 \times 6$: N86-2606-46
- N : N29-0205-04

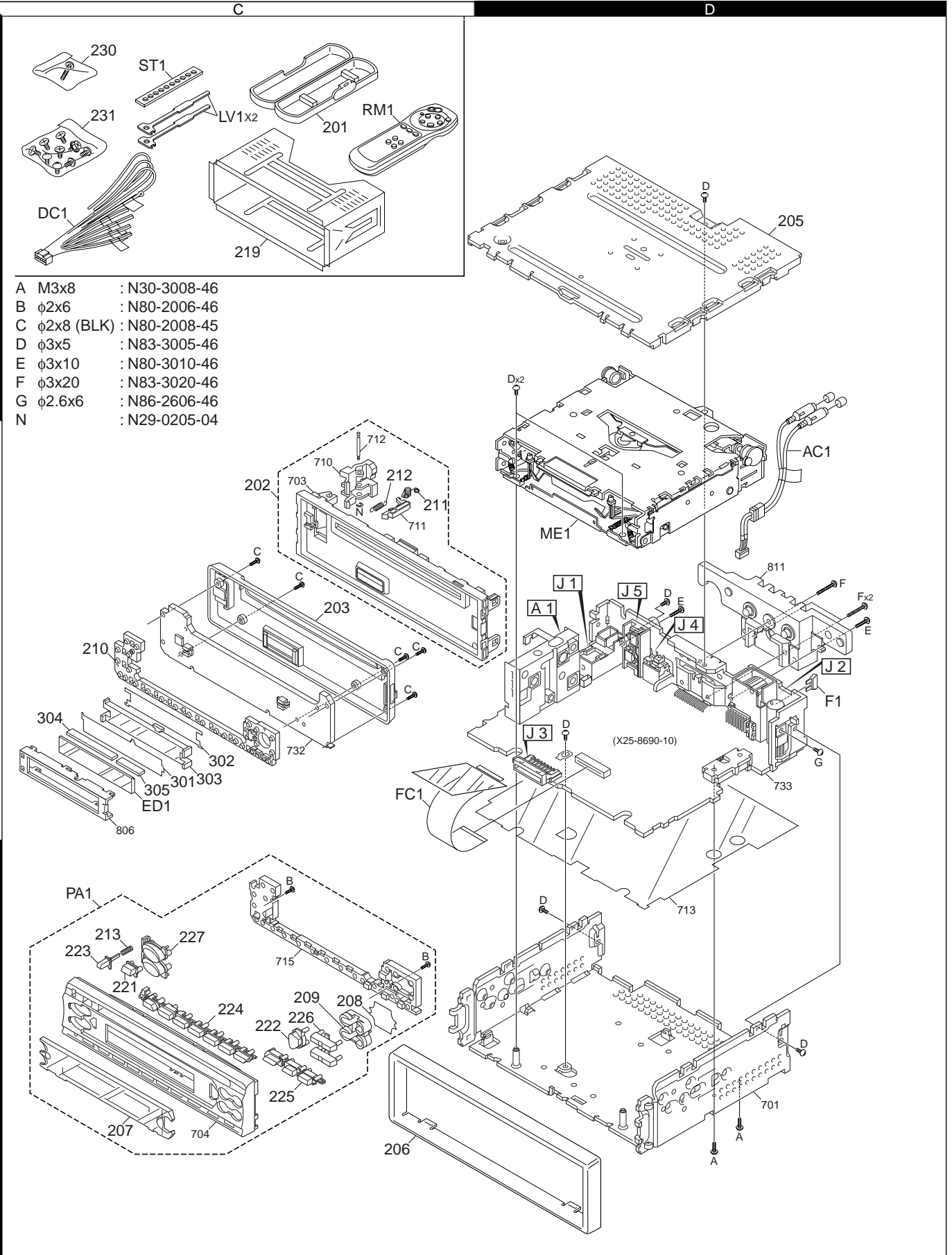

Parts with exploded numbers larger than 700 are not supplied.

KDC-416S/4018/G

PARTS LIST

* New Parts

Parts without Parts No. are not supplied.

Les articles non mentionnes dans le Parts No. ne sont pas fournis.

Teile ohne Parts No. werden nicht geliefert.

KDC-416S/4018/G

SWITCH UNIT(X13-9870-10)
ELECTRIC UNIT(X25-8690-XX)

Ref.No.	A d d	N e w	Parts No.	Description	Dest inati on
KDC-416S/4018/G					
201	1C		A02-1486-13	PLASTIC CABINET ASSY	
202	2C		A22-2863-03	SUB PANEL ASSY	
203	2C		A46-1694-01	REAR COVER	
205	1D		A52-0783-02	TOP PLATE	
PA1	3C	*	A64-2198-02	PANEL ASSY	K
PA1	3C	*	A64-2203-02	PANEL ASSY	M
PA1	3C	*	A64-2208-02	PANEL ASSY	M1
RM1	1C		A70-0883-05	REMOTE CONTROLLER ASSY	M,M1
206	3C		B07-3001-02	ESCUTCHEON	M,K
206	3C	*	B07-3003-02	ESCUTCHEON	M1
207	3C		B10-3290-01	FRONT GLASS	K
207	3C	*	B10-3295-01	FRONT GLASS	M,M1
208	3C		B11-1345-04	OPTICAL DIFFUSER	
209	3C		B19-2076-03	LIGHTING BOARD	
-			B46-0100-50	WARRANTY CARD	
-			B46-0606-04	ID CARD	
-		*	B64-1830-00	INSTRUCTION MANUAL	K
-		*	B64-1831-00	INSTRUCTION MANUAL E,T	M,M1
-		*	B64-1832-00	INSTRUCTION MANUAL A	M,M1
LV1	1C		D10-4589-04	LEVER	
210	2C		E29-1830-02	CONDUCTIVE RUBBER	
AC1	2D		E30-4801-05	CORD WITH PINPLUG	
DC1	1C		E30-4783-05	DC CORD	K
DC1	1C		E30-4784-05	DC CORD	M,M1
FC1	2C		E39-0343-05	FLAT CABLE	
F1	2D		F52-0006-05	FUSE(MINI BLADE TYPE)	
F1	2D		F52-0011-05	FUSE(MINI BLADE TYPE)	
211	3C		G01-2987-04	TORSION COIL SPRING	
212	3C		G01-2988-04	EXTENSION SPRING	
213	3C		G01-2990-04	COMPRESSION SPRING	
-			H10-4740-02	POLYSTYRENE FOAMED FIXTURE	
-			H25-0329-04	PROTECTION BAG (280X450X0.03)	
-			H25-0337-04	PROTECTION BAG (180X300X0.03)	
-		*	H54-1892-03	ITEM CARTON CASE	K
-		*	H54-1897-03	ITEM CARTON CASE	M
-		*	H54-1898-03	ITEM CARTON CASE	M1
219	1C		J21-9641-03	MOUNTING HARDWARE ASSY	
ST1	1C		J54-0606-04	STAY	
221	3C		K24-3653-04	KNOB EJ	
222	3C		K24-3652-04	KNOB Q	
223	3C		K24-3665-04	KNOB RELEASE	
224	3C		K25-1253-03	KNOB 1-6	
225	3C		K25-1254-03	KNOB CLK	
226	3C		K25-1255-03	KNOB FM/AM	
227	3C		K25-1256-03	KNOB VOL	
230	1C		N99-1610-15	SCREW SET	
231	1C		N99-1632-05	SCREW SET	
A	3D		N30-3008-46	PAN HEAD MACHINE SCREW	
B	3C		N80-2006-46	PAN HEAD TAPTITE SCREW	

Ref.No.	A d d	N e w	Parts No.	Description	Dest inati on
C	3C		N80-2008-45	PAN HEAD TAPTITE SCREW	
D	1D		N83-3005-46	PAN HEAD TAPTITE SCREW	
N	2C		N29-0205-04	RETAINING RING (1.5IU)	
ME1	2D		X92-4130-00	MECHANISM ASSY	
SWITCH UNIT (X13-9870-10)					
301	3C		B11-1327-04	OPTICAL DIFFUSER	
302	3C		B11-1328-04	REFLECTION SHEET	
303	3C		B19-2065-03	LIGHTING BOARD	
D1-14			B30-1533-05	LED(1608,PG)	
D17			B30-1564-05	LED(1608,BLUE)	
D18,19			B30-1572-05	LED(WHITE)	
ED1			B38-1059-05	LIQUID CRYSTAL	
C1			CK73GB1H102K	CHIP C 1000PF K	
C2,3			CK73GB1E473K	CHIP C 0.047UF K	
C2,3			CK73GB1H473K	CHIP C 0.047UF K	
C4			CK73GB1H103K	CHIP C 0.010UF K	
C5			CK73EB1C225K	CHIP C 2.2UF K	
C7-9			CK73GB1H103K	CHIP C 0.010UF K	
304	3C		E29-1829-04	CONDUCTIVE RUBBER	
305	3C		E29-1834-04	CONDUCTIVE RUBBER	
J1			E59-0828-05	RECTANGULAR PLUG	
CP1			R90-0724-05	MULTI-COMP 1K X4	
CP2,3			R90-0725-05	MULTI-COMP 1K X2	
R1			RK73FB2A102J	CHIP R 1.0K J 1/10W	
R2-4			RK73FB2A471J	CHIP R 470 J 1/10W	
R5			RK73FB2A102J	CHIP R 1.0K J 1/10W	
R6			RK73GB1J473J	CHIP R 47K J 1/16W	
R7			RK73GB1J102J	CHIP R 1.0K J 1/16W	
R8			RK73GB1J563J	CHIP R 56K J 1/16W	
R9			RK73GB1J102J	CHIP R 1.0K J 1/16W	
R10			RK73EB2B4R7J	CHIP R 4.7 J 1/8W	
R12			RK73FB2A102J	CHIP R 1.0K J 1/10W	
R13			RK73FB2A470J	CHIP R 47 J 1/10W	
R14-16			RK73EB2B331J	CHIP R 330 J 1/8W	
R17,18			RK73EB2B511J	CHIP R 510 J 1/8W	
R19			RK73EB2B361J	CHIP R 360 J 1/8W	
R20			RK73EB2B271J	CHIP R 270 J 1/8W	
D22,23			DA204K	DIODE	
IC1			LC75883E	MOS-IC	
IC2			RS-171	ANALOGUE IC	
Q1			DTA114EK	DIGITAL TRANSISTOR	
Q1			KRA102S	DIGITAL TRANSISTOR	
Q1			UN2111	DIGITAL TRANSISTOR	
ELECTRIC UNIT (X25-8690-XX)					
D102			B30-1567-05	LED(1608,RED)	
C1			C90-2853-05	ELECTRO 4700UF 16WV	
C21			CK73GB1H103K	CHIP C 0.010UF K	
C40			CK73GB1H103K	CHIP C 0.010UF K	
C50,51			CE04CW1E100M	ELECTRO 10UF 25WV	
C52-54			C90-2597-05	ELECTRO 10UF 16WV	

K: KDC-416S M: KDC-4018 M1: KDC-4018G

⚠ indicates safety critical components.

KDC-416S/4018/G

PARTS LIST

* New Parts

Parts without Parts No. are not supplied.

Les articles non mentionnés dans le Parts No. ne sont pas fournis.

Teile ohne Parts No. werden nicht geliefert.

ELECTRIC UNIT(X25-8690-XX)

Ref.No.	A d d	N e w	Parts No.	Description	Dest inati on
C55			CE04CW1E100M	ELECTRO 10UF 25WV	
C56			CE04CW1H100M	ELECTRO 10UF 50WV	
C57			C90-2926-05	ELECTRO 220UF 16WV	
C63			CE04CW1C220M	ELECTRO 22UF 16WV	
C101			CE04CW0J101M	ELECTRO 100UF 6.3WV	
C102			CK73GB1H103K	CHIP C 0.010UF K	
C103			CK73GB1C104K	CHIP C 0.10UF K	
C103			CK73GB1H104K	CHIP C 0.10UF K	
C104,105			CC73GCH1H150J	CHIP C 15PF J	
C106			CK73GB1H472K	CHIP C 4700PF K	
C142			CK73GB1C104K	CHIP C 0.10UF K	
C142			CK73GB1H104K	CHIP C 0.10UF K	
C201			CE04CW1A470M	ELECTRO 47UF 10WV	
C202			CK73GB1H103K	CHIP C 0.010UF K	
C203-205			C90-2610-05	ELECTRO 2.2UF 50WV	
C206			CK73GB1H153K	CHIP C 0.015UF K	
C207			CK73GB1A474K	CHIP C 0.47UF K	
C208,209			CK73GB1C104K	CHIP C 0.10UF K	
C208,209			CK73GB1H104K	CHIP C 0.10UF K	
C210			CK73GB1E333K	CHIP C 0.033UF K	
C210			CK73GB1H333K	CHIP C 0.033UF K	
C211			CC73GCH1H151J	CHIP C 150PF J	
C221-224			C90-2597-05	ELECTRO 10UF 16WV	
C225,226			CK73GB1H103K	CHIP C 0.010UF K	
C251-254			C90-5296-05	NP-ELECT 0.22UF 50WV	
C255			C90-2608-05	ELECTRO 1.0UF 50WV	
C256			CE04CW1A101M	ELECTRO 100UF 10WV	
C257			C90-2608-05	ELECTRO 1.0UF 50WV	
C258			C90-2935-05	ELECTRO 1.0UF 50WV	
C301			CE04CW1A101M	ELECTRO 100UF 10WV	
C302,303			CK73GB1H103K	CHIP C 0.010UF K	
C304			CE04CW1A101M	ELECTRO 100UF 10WV	
C305			CK73GB1H103K	CHIP C 0.010UF K	
C306			C90-2594-05	ELECTRO 10UF 10WV	
C307			CK73GB1H103K	CHIP C 0.010UF K	
C401,402			C90-2608-05	ELECTRO 1.0UF 50WV	
C403			CE04CW1A101M	ELECTRO 100UF 10WV	
C404			CK73GB1H103K	CHIP C 0.010UF K	
CN1			E40-9550-05	FLAT CABLE CONNECTOR	
CN2			E40-3238-05	PIN ASSY	
J1			E04-0312-05	RF COAXIAL CABLE RECEPTACLE	
J2			E58-0863-15	RECTANGULAR RECEPTACLE	
J3			E58-0879-05	RECTANGULAR RECEPTACLE	
J4			E56-0834-05	CYLINDRICAL RECEPTACLE	
J5			E63-0852-05	PIN JACK	
P1			E23-0745-05	TERMINAL	
L1			L33-1170-05	CHOKE COIL ASSY	
L4			L33-1123-05	LINE FILTER COIL	
L101			L40-4795-91	SMALL FIXED INDUCTOR(4.7UH,J)	
L201			L40-4795-91	SMALL FIXED INDUCTOR(4.7UH,J)	
L303-306			L40-4795-91	SMALL FIXED INDUCTOR(4.7UH,J)	
X1			L77-1167-05	CRYSTAL RESONATOR(4.19M)	
D	2D		N83-3005-46	PAN HEAD TAPTITE SCREW	

Ref.No.	A d d	N e w	Parts No.	Description	Dest inati on
E	2D		N80-3010-46	PAN HEAD TAPTITE SCREW	
F	2D		N83-3020-46	PAN HEAD TAPTITE SCREW	
G	2D		N86-2606-46	BINDING HEAD TAPTITE SCREW	
CP1			R90-1056-05	MULTIPLE RESISTOR	
CP2			R90-1047-05	MULTIPLE RESISTOR	
CP3			R90-1046-05	MULTIPLE RESISTOR	
R10			RK73FB2A303J	CHIP R 30K J 1/10W	
R11			RK73GB1J103J	CHIP R 10K J 1/16W	
R12			RK73GB1J104J	CHIP R 100K J 1/16W	
R20			RD14DB2H332J	SMALL-RD 3.3K J 1/2W	
R22			RK73GB1J103J	CHIP R 10K J 1/16W	
R23			RK73GB1J104J	CHIP R 100K J 1/16W	
R51			RK73GB1J473J	CHIP R 47K J 1/16W	
R57			RK73FB2A152J	CHIP R 1.5K J 1/10W	
R58			RK73GB1J472J	CHIP R 4.7K J 1/16W	
R67			RK73GB1J103J	CHIP R 10K J 1/16W	
R71			RK73FB2A823J	CHIP R 82K J 1/10W	
R72			RK73FB2A363J	CHIP R 36K J 1/10W	
R73			RK73GB1J104J	CHIP R 100K J 1/16W	
R102			RK73GB1J102J	CHIP R 1.0K J 1/16W	
R103,104			RK73GB1J222J	CHIP R 2.2K J 1/16W	
R105			RK73GB1J471J	CHIP R 470 J 1/16W	
R106			RK73GB1J104J	CHIP R 100K J 1/16W	
R107,108			RK73GB1J222J	CHIP R 2.2K J 1/16W	
R110			RK73GB1J472J	CHIP R 4.7K J 1/16W	
R113,114			RK73GB1J473J	CHIP R 47K J 1/16W	
R115			RK73GB1J102J	CHIP R 1.0K J 1/16W	
R116			RK73GB1J103J	CHIP R 10K J 1/16W	
R117			RK73GB1J102J	CHIP R 1.0K J 1/16W	
R118			RK73GB1J103J	CHIP R 10K J 1/16W	
R119			RK73GB1J473J	CHIP R 47K J 1/16W	
R121,122			RK73GB1J222J	CHIP R 2.2K J 1/16W	
R125			RK73GB1J102J	CHIP R 1.0K J 1/16W	
R126			RK73GB1J104J	CHIP R 100K J 1/16W	
R127			RK73GB1J222J	CHIP R 2.2K J 1/16W	
R128			RK73GB1J225J	CHIP R 2.2M J 1/16W	
R129,130			RK73GB1J222J	CHIP R 2.2K J 1/16W	
R131			RK73GB1J682J	CHIP R 6.8K J 1/16W	
R132			RK73GB1J223J	CHIP R 22K J 1/16W	
R133			RK73GB1J164J	CHIP R 160K J 1/16W	
R136-138			RK73GB1J473J	CHIP R 47K J 1/16W	
R139			RK73GB1J473J	CHIP R 47K J 1/16W	
R143			RK73FB2A222J	CHIP R 2.2K J 1/10W	
R144			RK73GB1J104J	CHIP R 100K J 1/16W	
R201			RK73GB1J272J	CHIP R 2.7K J 1/16W	
R202,203			RK73GB1J472J	CHIP R 4.7K J 1/16W	
R221-224			RK73FB2A271J	CHIP R 270 J 1/10W	
R251			RK73GB1J472J	CHIP R 4.7K J 1/16W	
R254			RK73GB1J472J	CHIP R 4.7K J 1/16W	
R255			RK73GB1J333J	CHIP R 33K J 1/16W	
R256			RK73FB2A102J	CHIP R 1.0K J 1/10W	
R257			RK73GB1J362J	CHIP R 3.6K J 1/16W	
R258			RK73GB1J101J	CHIP R 100 J 1/16W	
R260			RK73GB1J751J	CHIP R 750 J 1/16W	

K: KDC-416S M: KDC-4018 M1: KDC-4018G

⚠ indicates safety critical components.

KDC-416S/4018/G

PARTS LIST

* New Parts

Parts without Parts No. are not supplied.

Les articles non mentionnés dans le Parts No. ne sont pas fournis.

Teile ohne Parts No. werden nicht geliefert.

ELECTRIC UNIT(X25-8690-XX)
CD PLAYER UNIT(X32-5010-00)

Ref.No.	A d d	N e w	Parts No.	Description	Dest inati on
R261			RK73GB1J431J	CHIP R 430 J 1/16W	
R263			RK73GB1J184J	CHIP R 180K J 1/16W	
R264			RK73GB1J473J	CHIP R 47K J 1/16W	
R412-415			RK73GB1J104J	CHIP R 100K J 1/16W	
W151			R92-2053-05	CHIP R 0 J 1/8W	
W152			R92-1252-05	CHIP R 0 OHM	
W155			R92-1252-05	CHIP R 0 OHM	
W156,157			R92-2053-05	CHIP R 0 J 1/8W	
W158,159			R92-1252-05	CHIP R 0 OHM	
W160-165			R92-2053-05	CHIP R 0 J 1/8W	
W167-169			R92-1252-05	CHIP R 0 OHM	
D1			S2V20*A	DIODE	
D2,3			1SS133	DIODE	
D4			IMSA-6801	SURGE ABSORBER	
D4			SA-C2012-101TB	SURGE ABSORBER	
D10			MA4068(N)-M	ZENER DIODE	
D11			D1F60	DIODE	
D12-14			AM01Z	DIODE	
D12-14			DSM1SD2	DIODE	
D12-14			ERA15-02	DIODE	
D20			MA4068(N)-M	ZENER DIODE	
D40			1SS133	DIODE	
D50			1SS133	DIODE	
D51			HZS9A1L	ZENER DIODE	
D51			MA4082(N)-L	ZENER DIODE	
D70			MA4068(N)-M	ZENER DIODE	
D101			1SS133	DIODE	
D103,104			1SS133	DIODE	
D106,107			HZS6C1	ZENER DIODE	
D106,107			MA4062-L	ZENER DIODE	
D201,202			MA4068(N)-M	ZENER DIODE	
D251-253			1SS133	DIODE	
D401,402			MA4068(N)-M	ZENER DIODE	
D403,404			HZS6C1	ZENER DIODE	
D403,404			MA4062-L	ZENER DIODE	
D409-411			HZS6C1	ZENER DIODE	
D409-411			MA4062-L	ZENER DIODE	
IC1			UPD780058GC230	MI-COM IC	
IC2			TDA7407D	ANALOGUE IC	
IC4			TDA7386	ANALOGUE IC	
IC7			BA4911-V4	ANALOGUE IC	
IC8			HD74HC27FP	MOS-IC	
IC11			S-80830ANNP	MOS-IC	
IC12			BR24C01AF	MEMORY IC	
IC12			BR24C01AF-W	MEMORY IC	
IC12			M24C01-WMN6T	MEMORY IC	
IC12			S-24C01B	MEMORY IC	
Q10			2SC4081	TRANSISTOR	
Q10			2SD1819A	TRANSISTOR	
Q20			2SC4081	TRANSISTOR	
Q20			2SD1819A	TRANSISTOR	
Q40			DTA124EUA	DIGITAL TRANSISTOR	
Q40			UN5112	DIGITAL TRANSISTOR	
Q50			2SA1036K	TRANSISTOR	

Ref.No.	A d d	N e w	Parts No.	Description	Dest inati on
Q51			UMC2N	TRANSISTOR	
Q53			UMC2N	TRANSISTOR	
Q55			2SD2375	TRANSISTOR	
Q55			2SD2396	TRANSISTOR	
Q70			2SC4081	TRANSISTOR	
Q70			2SD1819A	TRANSISTOR	
Q101			2SC4081	TRANSISTOR	
Q101			2SD1819A	TRANSISTOR	
Q102			DTA114YUA	DIGITAL TRANSISTOR	
Q102			UN5114	DIGITAL TRANSISTOR	
Q221-224			DTC143TUA	DIGITAL TRANSISTOR	
Q221-224			UN5216	DIGITAL TRANSISTOR	
Q251			DTC114YUA	DIGITAL TRANSISTOR	
Q251			UN5214	DIGITAL TRANSISTOR	
TH1			PTH9C42BE471Q	POSITIVE RESISTOR	
A1	2D		X86-3300-10	TUNER UNIT	

CD PLAYER UNIT (X32-5010-00)

Ref.No.	A d d	N e w	Parts No.	Description	Dest inati on
C1,2			CK73FB1C105K	CHIP C 1.0UF K	
C3			CK73FB0J475K	CHIP C 4.7UF K	
C4			C92-0566-05	CHIP-TAN 10UF 6.3WV	
C5			CC73GCH1H330J	CHIP C 33PF J	
C6			CC73GCH1H030C	CHIP C 3.0PF C	
C7			CK73GB1C104K	CHIP C 0.10UF K	
C8			CK73FB1C105K	CHIP C 1.0UF K	
C10			CK73GB1H472K	CHIP C 4700PF K	
C11			CK73GB1H682K	CHIP C 6800PF K	
C12			CK73GB1H332K	CHIP C 3300PF K	
C13			CK73GB1C333K	CHIP C 0.033UF K	
C14			CK73GB1H472K	CHIP C 4700PF K	
C15			CK73GB1C473K	CHIP C 0.047UF K	
C16			CC73GCH1H221J	CHIP C 220PF J	
C17			CK73GB1H472K	CHIP C 4700PF K	
C18			CC73GCH1H471J	CHIP C 470PF J	
C19,20			CK73GB1C104K	CHIP C 0.10UF K	
C21			CK73FB0J475K	CHIP C 4.7UF K	
C23			CK73GB1H102K	CHIP C 1000PF K	
C24			CK73GB1E223K	CHIP C 0.022UF K	
C25			CK73GB1H153K	CHIP C 0.015UF K	
C26			CK73GB0J105K	CHIP C 1.0UF K	
C28			CK73GB0J105K	CHIP C 1.0UF K	
C29			CK73GB1C104K	CHIP C 0.10UF K	
C33			CK73GB1C104K	CHIP C 0.10UF K	
C35			CK73GB1C104K	CHIP C 0.10UF K	
C41			CK73EB1C225K	CHIP C 2.2UF K	
C43			CK73GB1H153K	CHIP C 0.015UF K	
C45			CK73GB1H153K	CHIP C 0.015UF K	
C46			CK73GB1C473K	CHIP C 0.047UF K	
C55			CK73GB1C104K	CHIP C 0.10UF K	
C68			CK73GB1C104K	CHIP C 0.10UF K	
C71,72			CK73GB1H471K	CHIP C 470PF K	
C77,78			CC73GCH1H680J	CHIP C 68PF J	
C79,80			CK73GB1H222K	CHIP C 2200PF K	
C85			CK73GB1C104K	CHIP C 0.10UF K	
C89			CK73GB1H222K	CHIP C 2200PF K	

K: KDC-416S M: KDC-4018 M1: KDC-4018G

⚠ indicates safety critical components.

KDC-416S/4018/G

PARTS LIST

* New Parts

Parts without Parts No. are not supplied.

Les articles non mentionnés dans le Parts No. ne sont pas fournis.

Teile ohne Parts No. werden nicht geliefert.

CD PLAYER UNIT(X32-5010-00)

MECHANISM ASSY(X92-4130-00)

Ref.No.	A d d	N e w	Parts No.	Description	Dest inati on
C90			CK73GB1C104K	CHIP C 0.10UF K	
CN1			E40-9536-05	FLAT CABLE CONNECTOR	
CN2			E40-9339-05	FLAT CABLE CONNECTOR	
CN2			E41-0036-05	FLAT CABLE CONNECTOR	
CN2			E41-0129-05	FLAT CABLE CONNECTOR	
X1			L78-0572-05	RESONATOR (16.93MHZ)	
CP1-3			R90-1019-05	MULTI-COMP 100 X 2	
R3			RK73GB1J272J	CHIP R 2.7K J 1/16W	
R5			RK73GB1J151J	CHIP R 150 J 1/16W	
R6			RK73GB1J272J	CHIP R 2.7K J 1/16W	
R8			RK73EB2B4R7J	CHIP R 4.7 J 1/8W	
R9			RK73EB2B100J	CHIP R 10 J 1/8W	
R10,11			RK73GB1J682J	CHIP R 6.8K J 1/16W	
R12			RK73GB1J432J	CHIP R 4.3K J 1/16W	
R15			RK73GB1J824J	CHIP R 820K J 1/16W	
R16			RK73GB1J223J	CHIP R 22K J 1/16W	
R17			RK73GB1J363J	CHIP R 36K J 1/16W	
R18			RK73GB1J392J	CHIP R 3.9K J 1/16W	
R19			RK73GB1J333J	CHIP R 33K J 1/16W	
R20			RK73GB1J104J	CHIP R 100K J 1/16W	
R21			RK73GB1J334J	CHIP R 330K J 1/16W	
R32			RK73GB1J104J	CHIP R 100K J 1/16W	
R34			RK73GB1J683J	CHIP R 68K J 1/16W	
R36			RK73GB1J151J	CHIP R 150 J 1/16W	
R37			RK73GB1J471J	CHIP R 470 J 1/16W	
R38			RK73GB1J224J	CHIP R 220K J 1/16W	
R46			RK73GB1J102J	CHIP R 1.0K J 1/16W	
R47			RK73GB1J103J	CHIP R 10K J 1/16W	
R49			RK73GB1J472J	CHIP R 4.7K J 1/16W	
R52			RK73GB1J104J	CHIP R 100K J 1/16W	
R54			RK73GB1J104J	CHIP R 100K J 1/16W	
R71			RK73GB1J103J	CHIP R 10K J 1/16W	
R72			RK73GB1J102J	CHIP R 1.0K J 1/16W	
R73			RK73GB1J473J	CHIP R 47K J 1/16W	
R75			RK73GB1J333J	CHIP R 33K J 1/16W	
R76			RK73GB1J622J	CHIP R 6.2K J 1/16W	
R77			RK73GB1J563J	CHIP R 56K J 1/16W	
R78			RK73GB1J243J	CHIP R 24K J 1/16W	
R81			RK73GB1J333J	CHIP R 33K J 1/16W	
R82			RK73GB1J123J	CHIP R 12K J 1/16W	
R83			RK73GB1J102J	CHIP R 1.0K J 1/16W	
R102			RK73GB1J332J	CHIP R 3.3K J 1/16W	
R104			RK73GB1J562J	CHIP R 5.6K J 1/16W	
R107,108			RK73FB2A331J	CHIP R 330 J 1/10W	
R117,118			RK73FB2A203J	CHIP R 20K J 1/10W	
R121,122			RK73FB2A203J	CHIP R 20K J 1/10W	
R125,126			RK73FB2A203J	CHIP R 20K J 1/10W	
R202			RK73GB1J104J	CHIP R 100K J 1/16W	
R214			RK73GB1J104J	CHIP R 100K J 1/16W	
R218			RK73GB1J473J	CHIP R 47K J 1/16W	
R233			RK73GB1J622J	CHIP R 6.2K J 1/16W	
R234			RK73GB1J103J	CHIP R 10K J 1/16W	
R238			RK73FB2A201J	CHIP R 200 J 1/10W	

Ref.No.	A d d	N e w	Parts No.	Description	Dest inati on
W17			R92-2053-05	CHIP R 0 J 1/8W	
S1,2			S68-0838-05	PUSH SWITCH	
S3			S68-0859-05	PUSH SWITCH	
D1,2			DAN202U	DIODE	
D3			DA204U	DIODE	
D4			DAN202U	DIODE	
D5			MA8051-L	ZENER DIODE	
IC1			AN22000AA	ANALOGUE IC	
IC2			MN662774KG1	MOS-IC	
IC4			BA5917AFP	ANALOGUE IC	
IC6			NJM4565MD	IC(OP AMP X2)	
Q1			MCH6101	TRANSISTOR	
Q2			DTC124EUA	DIGITAL TRANSISTOR	
Q3			DTA143XUA	DIGITAL TRANSISTOR	
Q4			2SA1362(Y)	TRANSISTOR	
Q5			DTC124EUA	DIGITAL TRANSISTOR	
MECHANISM ASSY (X92-4130-00)					
1	2A		A10-4482-01	CHASSIS	
2	1B		A10-4225-33	CHASSIS CALKING ASSY	
3	2B		A11-0915-43	SUB CHASSIS CALKING ASSY	
6	2A		D10-4306-04	ARM ASSY	
7	2A		D10-4305-04	ARM ASSY	
8	3A		D10-3087-44	ARM ASSY	
9	3B		D10-3092-03	SLIDER	
10	3B		D10-3093-04	SLIDER ASSY	
11	2B		D10-3095-04	SLIDER ASSY	
12	2B		D10-3096-04	SLIDER ASSY	
13	1A		D10-3099-24	SLIDER ASSY	
14	1A		D10-3100-04	SLIDER ASSY	
16	1B		D10-4004-04	LEVER ASSY	
17	1B		D10-4006-04	LEVER	
18	1A		D10-4007-04	LEVER	
19	2B		D10-4008-14	LEVER	
20	2A		D10-4009-23	ARM	
21	3A		D10-4010-04	LEVER	
22	3A		D10-4307-04	LEVER ASSY	
24	3B		D10-4050-04	ARM	
25	3A		D10-4038-23	ARM ASSY	
26	2A		D10-4123-24	LEVER ASSY	
27	3A		D13-1442-03	RACK (GEAR)	
29	3B		D13-1231-04	GEAR	
30	3A		D13-1240-04	GEAR	
31	3B		D13-1233-04	GEAR	
32	3B		D13-1234-14	GEAR ASSY	
33	3A		D13-1441-03	GEAR	
34	3B		D13-1232-04	GEAR	
35	3B		D13-1241-04	GEAR	
36	3A		D13-1242-04	GEAR	
37	1B		D13-1243-04	GEAR	
38	1B		D13-1244-04	GEAR	
39	1B		D13-1245-14	GEAR	
40	2A		D13-1246-04	GEAR	
41	2B		D13-1247-04	GEAR	

K: KDC-416S M: KDC-4018 M1: KDC-4018G

▲ indicates safety critical components.

KDC-416S/4018/G

PARTS LIST

* New Parts

Parts without Parts No. are not supplied.

Les articles non mentionnes dans le Parts No. ne sont pas fournis.

Teile ohne Parts No. werden nicht geliefert.

MECHANISM ASSY(X92-4130-00)

Ref.No.	Added	New	Parts No.	Description	Destination
43	2B		D13-1249-04	GEAR ASSY	
44	2B		D13-1341-04	GEAR ASSY (LEAD SCREW)	
45	1B		D14-0668-04	ROLLER	
46	2A		D14-0670-04	ROLLER	
47	3B		D14-0674-04	ROLLER	
49	3A		D21-2228-14	SHAFT	
50	1A		D21-2229-04	SHAFT	
51	1A		D23-0925-24	RETAINER	
52	2A		D32-0614-04	STOPPER	
53	1B		D39-0223-05	DAMPER (YELLOW)	
54	2B		D39-0224-05	DAMPER (BLACK)	
55	3B		F09-1246-04	SHEET	
58	3B		F09-1266-14	SHEET	
60	2A		G01-2770-04	EXTENSION SPRING	
61	3A		G01-2771-04	EXTENSION SPRING	
62	3A		G01-2772-24	EXTENSION SPRING	
63	3A		G01-2773-14	EXTENSION SPRING	
64	3A		G01-2774-34	EXTENSION SPRING	
65	1B		G01-2775-04	TORSION COIL SPRING	
66	1B		G01-2776-14	TORSION COIL SPRING	
67	3B		G01-2777-24	TORSION COIL SPRING	
69	2A		G01-2844-04	EXTENSION SPRING	
70	2A		G02-1231-04	FLAT SPRING	
71	2B		G02-1232-24	FLAT SPRING	
72	2A		G02-1241-24	FLAT SPRING	
75	2A		J11-0613-13	CLAMPER	
76	3A		J19-4678-13	HOLDER	
77	2B		J19-4679-24	HOLDER	
78	3B		J21-7684-13	MOUNTING HARDWARE	
79	2B		J21-7686-13	MOUNTING HARDWARE	
80	1B		J21-7690-03	MOUNTING HARDWARE	
82	3A		J84-0107-05	FLEXIBLE PRINTED WIRING BOARD	
83	1A		J90-0757-22	GUIDE	
A	2A		N09-4249-05	MACHINE SCREW (M1.7X2.5,LOCK)	
B	1B		N09-4172-05	TAPPING SCREW (2X3.5,CTITE)	
C	2B		N09-4202-05	STEPPED SCREW	
D	2A		N38-2020-46	PAN HEAD MACHIN SCREW	
E	3A		N09-4294-05	TAPTITE SCREW (BIND P TAPTIT)	
F	3B		N19-2023-04	FLAT WASHER	
G	2A		N19-2058-04	FLAT WASHER	
H	3A		N19-2093-04	FLAT WASHER	
J	2A		N39-2020-46	PAN HEAD MACHIN SCREW	
DM1	3B		T42-0764-04	DC MOTOR ASSY	
DM2	3B		T42-0763-04	DC MOTOR ASSY	
DPU1	2B		T25-0215-05	OPTICAL PICKUP HEAD	

Ref.No.	Added	New	Parts No.	Description	Destination
---------	-------	-----	-----------	-------------	-------------

KDC-416S/4018/G

SPECIFICATIONS

KDC-416S

FM Section

Frequency Range	87.9MHz~107.9MHz
(Frequency Step)	(200kHz)
Channel Space Selection	50k/200kHz
Usable Sensitivity(S/N:30dB)	9.3dBf (0.8 μ V/75 Ω)
Quieting Sensitivity(S/N:50dB)	15.2dBf (1.6 μ V/75 Ω)
Frequency Response(\pm 3.0dB)	30Hz~15kHz
S/N	70dB (MONO)
Selectivity	\geq 80dB(\pm 400kHz)
Stereo Separation	40dB(1kHz)

AM Section

Frequency Range	530kHz~1700kHz
(Frequency Step)	(10kHz)
Channel Space Selection	9k/10kHz
Usable Sensitivity(S/N:20dB)	28dB μ (25 μ V)

CD Section

Laser Diode	GaAlAs(λ =780nm)
Digital Filter(D/A)	8 Times Over Sampling
D/A Converter	1Bit
Spindle Speed	500~200(CLV)
Wow & Flutter	Below Measurable Limit
Frequency Response	10~20kHz(\pm 1dB)
THD	0.01%(1kHz)
S/N Ratio	96dB(1kHz)
Dynamic Range	93dB
Channel Separation	85dB

KDC-4018/G

FM Section

Frequency Range	87.5MHz~108.0MHz
(Frequency Step)	(50kHz)
Channel Space Selection	50k/200kHz
Usable Sensitivity(S/N:30dB)	9.3dBf (0.8 μ V/75 Ω)
Quieting Sensitivity(S/N:50dB)	15.2dBf (1.6 μ V/75 Ω)
Frequency Response(\pm 3.0dB)	30Hz~15kHz
S/N	70dB (MONO)
Selectivity	\geq 80dB(\pm 400kHz)
Stereo Separation	40dB(1kHz)

AM Section

Frequency Range	531kHz~1611kHz
(Frequency Step)	(9kHz)
Channel Space Selection	9k/10kHz
Usable Sensitivity(S/N:20dB)	28dB μ (25 μ V)

CD Section

Laser Diode	GaAlAs(λ =780nm)
Digital Filter(D/A)	8 Times Over Sampling
D/A Converter	1Bit
Spindle Speed	500~200(CLV)
Wow & Flutter	Below Measurable Limit
Frequency Response	10~20kHz(\pm 1dB)
THD	0.01%(1kHz)
S/N Ratio	96dB(1kHz)
Dynamic Range	93dB
Channel Separation	85dB

AMPLIFIER Section

Preout Level/Load	1800mV/10k Ω (CD/CD-CH)
Preout Impedance	\leq 600 Ω
Maximum Power	45W \times 4
Full Bandwidth Power	22W \times 4
(at less than 1%THD)	

TONE Section

Bass	100Hz \pm 10dB
Middle	1kHz \pm 10dB
Treble	10kHz \pm 10dB

General

Operating Voltage	14.4V
(11V~16V allowable)	
Current Consumption	10A
Installation Size (W)	182(mm) 7-3/16(in)
(H)	53(mm) 2-1/16(in)
(D)	157(mm) 6-3/16(in)
Weight	1.5kg(3.31lbs)

AMPLIFIER Section

Preout Level/Load (KDC-4018)	1800mV/10k Ω (CD/CD-CH)
Preout Level/Load (KDC-4018G)	1800mV/10k Ω (CD)
Preout Impedance	\leq 600 Ω
Maximum Power	45W \times 4
Full Bandwidth Power	22W \times 4
(at less than 1%THD)	

TONE Section

Bass	100Hz \pm 10dB
Middle	1kHz \pm 10dB
Treble	10kHz \pm 10dB

General

Operating Voltage	14.4V
(11V~16V allowable)	
Current Consumption	10A
Installation Size (W)	182(mm) 7-3/16(in)
(H)	53(mm) 2-1/16(in)
(D)	157(mm) 6-3/16(in)
Weight	1.5kg(3.31lbs)